

ASSEMBLY AND INSTALLATION INSTRUCTIONS

T0258 / T0259 / T0291 / T0292 / T0293

WARNING: TO AVOID RISK OF ELECTRICAL SHOCK, BE SURE TO SHUT OFF POWER BEFORE INSTALLING OR SERVICING THIS FIXTURE.

NOTES: 1. Before installing, consult local electrical codes for wiring and grounding requirements.
2. Read and save these instructions.

Important to Know

1. Read all instructions carefully before installation and operation.
2. If you are not familiar with state and local electrical codes, it is recommended that you consult with a qualified electrician.
3. Before installation, shut off power at the main fuse or circuit breaker box. Be aware that simply turning off the wall switch is not sufficient to prevent an electrical shock.
4. This fixture requires a 120 VAC, 60 Hz power source.
5. Do not attempt to take the lantern apart; there are no serviceable parts inside.
6. To avoid sensor damage by lightning or electrical surge, make sure the grounding wire is securely connected.
7. For general safety and to avoid any possible damage to the sensor, be sure the power is switched "off" before replacing the bulb.
8. Compatible with LED dimmable bulb.

Maximum Wattage: 60W Incandescent Bulb or 20W LED dimmable bulb.

Work Temperature: -4°F~104°F

Features

1. Energy saving fixture.
2. Use the dim-to-bright illumination option where you want some minimum illumination through out the night, such as at your front entrance or garage door. Use the dark-to-bright illumination option where you do not need minimum brightness, such as the backyard or back porch.
3. When in manual override mode, use wall switch to keep the light ON till dawn.

Hardware Package (included):

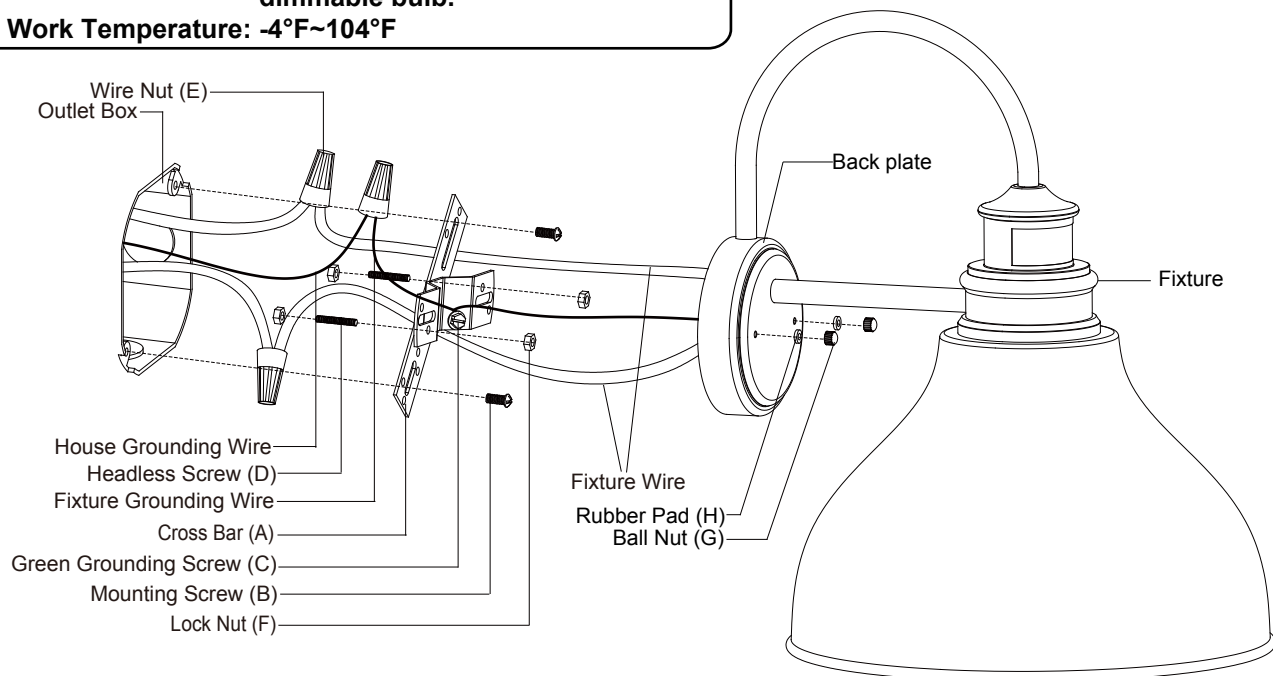
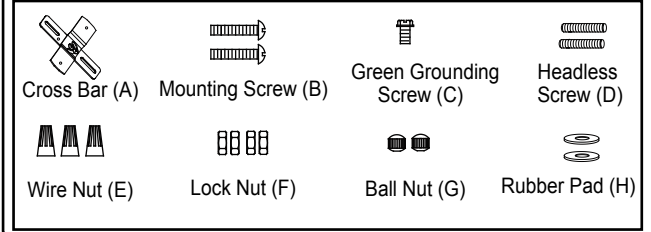

Type A Max. 60W Bulb OR
Max. 20W Dimmable LED Bulb
(not include)

Installation steps

Turn off the power at fuse or circuit box.

1. Thread two headless screws through the cross bar, and then secure them with four lock nuts (two on each side of the cross bar). Adjust the length of the headless screws if necessary.
Note: Make sure that the headless screws are lined up horizontally to make the fixture level.
2. Attach cross bar to the outlet box using two mounting screws.
3. Pull out the source wires from the outlet box. Make wire connections using wire nuts as follows:
 - Connect the hot wire (usually black insulation) from the fixture to the black wire from the power source.
 - Connect the neutral wire (usually white insulation) from the fixture to the white wire from the power source.
 - Attach the fixture grounding wire (usually green insulation or bare wire) to the cross bar with the green grounding screw, and then connect it to the house grounding wire with the wire nut.Carefully put the wires back into the outlet box.
4. Attach the fixture to the cross bar by inserting headless screws into holes on back plate, and then secure it with two rubber pads and two ball nuts.
NOTE:With silicone caulking compound, caulk completely around where the back plate meets with the wall surface to prevent water from seeping into the outlet box.
5. Install a bulb (not included). Check relamping label at socket area or packaging for maximum allowed wattage.

Turn on the power at fuse or circuit box.

Function and Operation

MODES OF OPERATION

Choose a mode by sliding the switch on the back of the sensor. When power is first applied, the light will turn on immediately. Wait for 100 seconds to allow the sensor to warm up.

1. TEST MODE (daytime and nighttime operation)
 - The light will turn to low-level brightness (0%~50% brightness). The light will turn to high-level brightness (100% brightness) when motion is detected, and stay on as long as the motion is continuing. The light will revert to low-level brightness about 5 seconds after motion is no longer detected.
2. 3H MODE (nighttime operation only)
 - At dusk, the light will turn to high-level brightness (100% brightness). The light will turn to low-level brightness (0%~50% brightness) automatically after 3 hours. The light will turn to high-level brightness (100% brightness) when motion is detected, and stay on as long as the motion is continuing. When motion is no longer detected, the light will remain on for the predetermined time you set (5~180 seconds), and then revert to low-level brightness you set.
 - Light will turn off automatically at dawn, and return to 3 H mode at dusk.
3. 6H MODE (nighttime operation only)
 - At dusk, the light will turn to high-level brightness (100% brightness). The light will turn to low-level brightness (0%~50% brightness) automatically after 6 hours. The light will turn to high-level brightness (100% brightness) when motion is detected, and stay on as long as the motion is continuing. When motion is no longer detected, the light will remain on for the predetermined time you set (5~180 seconds), and then revert to low-level brightness you set.
 - Light will turn off automatically at dawn, and return to 6 H mode at dusk.
4. 0 MODE (nighttime operation only)
 - The light will turn to low level brightness (0%~50% brightness) at dusk. The light will turn to high-level brightness (100% brightness) when motion is detected, and stay on as long as the motion is continuing. When motion is no longer detected, the light will remain on for the predetermined time you set (5~180 seconds), and then revert to low level brightness you set.
 - Light will turn off automatically at dawn, and return to 0 H mode at dusk.
5. Manual Override MODE (nighttime operation only; on at dusk, off at dawn)
 - In 3, 6 or 0 mode, to shift to manual override mode, turn off the wall switch in 3 seconds and then turn it on again, the light will turn to high-level brightness at dusk, and turn off automatically at dawn. To return to the previous settings, turn off the wall switch in 3 seconds and then turn it on again. (See Fig.1)
 - The lights will turn off automatically at dawn.

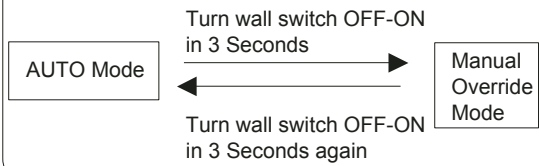
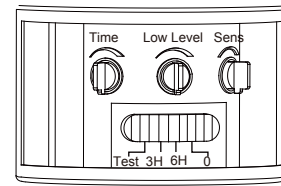
FIG.1**Manual Override Operation Diagram****FIG.2****On the back of the sensor****CUSTOMIZATION OPTIONS:****Shut-off Delay**

The Shut-off delay is the length of time the light will stay at high-level brightness after motion has ceased to be detected. This Shut-off delay can be set when operation is in 3, 6 or 0 Mode by using the “TIME” knob located on the left side of the panel at the back of the sensor lens (See Fig.2). To increase the shut-off delay, turn the knob clockwise. To decrease shut off delay, turn the knob counterclockwise. The delay may be adjusted from a minimum of 5 seconds to a maximum of 3 minutes. The light will stay on as long as motion is detected continuously and will automatically turn to low-level brightness when no more motion is detected after the delay time has passed.

Sensitivity of Motion Sensor

The sensitivity of the motion sensor can be adjusted by using the “Sens” knob located on the right side of the panel at the back of sensor lens (See Fig.2). To increase sensitivity, turn the knob clockwise. To decrease sensitivity, turn the knob counterclockwise. The sensitivity may be adjusted from a minimum of 5 feet to a maximum of 40 feet.

NOTE:

1. The sensitivity of the motion sensor will increase as the environmental temperature gets cooler. For best performance, gently clean the lens with a soft cloth every 1 or 2 months to assure maximum sensitivity.
2. For best performance, install fixture at least 6 feet above the ground. At such a height, the fixture will provide a detection distance of up to 40 feet at 77 degrees Fahrenheit. (See Fig.3)
3. The sensor detects across a detection range of 180 degrees. (See Fig.4)
4. The sensor will be more sensitive to motion across its detection path than motion directly towards it. (See Fig.5)
5. To reduce possible nuisances, do not mount the fixture near a heat source like an air conditioner, vent or furnace exhaust, or in a direction facing any reflecting object or other light source.

Where you install your lantern is important: Be sure the light is mounted straight on the wall; otherwise, the detection distance may be limited.

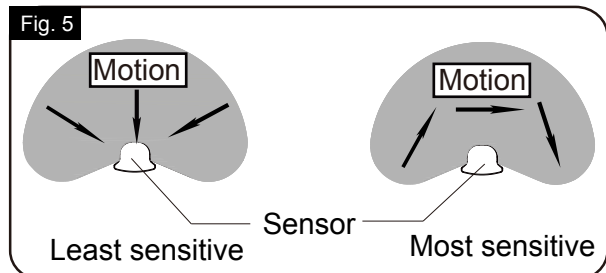
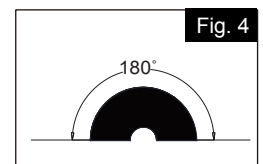
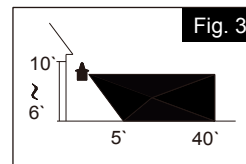
**Troubleshooting****---The light does not come on at all:**

1. Make sure the wall switch and circuit breaker are on.
2. Make sure the wiring is correct.
3. Make sure the bulb is not burned out.
4. Cover the sensor with your palm to verify that the ambient light level is not too high.

----In Test Mode, the light stays on full brightness after 5 seconds:

1. If during daytime, make sure the slide switch is at the TEST position.
2. Whether the motion is detected at all time.

---In 3H or 6H Mode, the light is still on full brightness, even though it has been 3 hours or 6 hours after dusk, respectively:

1. Make sure no motion could be picked up by the sensor.
2. Make sure that mode entry is not in manual override.

---After performing 3H or 6H Mode, the light stays on full brightness after 3 minutes:

1. Make sure there is no movement that could be picked up by the sensor.
2. Adjust the time knob counterclockwise to reduce the delay shut-off time.

----In 3H or 6H Mode, the light turns off completely, instead of low level brightness, after 3 minutes:

1. Make sure the bulb you installed is a medium base bulb or LED dimmable bulb.
2. Make sure the bulb is not burned out.
3. make sure the low level is not at the 0% position.

-- The light blinks:

1. Make sure the light is not mounted near a barbecue, air conditioner or other heat source.
2. Adjust the sensitivity knob counterclockwise to avoid unnecessary triggering like a passing car or reflecting objects.
3. Make sure the bulb is medium base bulb or Led dimmable bulb.

The following parts are available for re-order if damaged or missing.

Spare Parts List:

Cross Bar (A) Mounting Screw (B) Green Grounding Screw (C) Headless Screw (D)

Wire Nut (E) Lock Nut (F) Ball Nut (G) Rubber Pad (H)

Mounting Hardware 5424MM (1 SET) for T0258 T0259 T0291 T0292

Mounting Hardware 5661MM (1 SET) for T0293

5-YEAR LIMITED WARRANTY:

All products are warranted to be free of defects in material and workmanship for five (5) years from date of purchase. This warranty is limited to the correction of any such defect, or the replacement of any such defective item(s), provided that: (a) we are properly notified and consent to return of the item(s) in question:(b) the item (s) is / are returned with proof of purchase date; and (c) it is found upon inspection by us that the item (s) is / are defective as noted above. This warranty dose not cover labor costs, consequential damages, nor dose it apply to any item(s) that have been improperly installed, overloaded, altered, or otherwise abused by the customer, its agent(s) or employee(s). Finishes are specially excluded from the terms of this warranty since they are subject to environmental maintenance deemed beyond our control. Other than the described obligation, we assume no further liability with respect to the sale or use of our products. We make no warranty, express or implied, and disclaim any warranty of merchantability or fitness for a particular purpose.

