

LV205

ACCENT PATH, WALKWAY AND AREA LIGHT

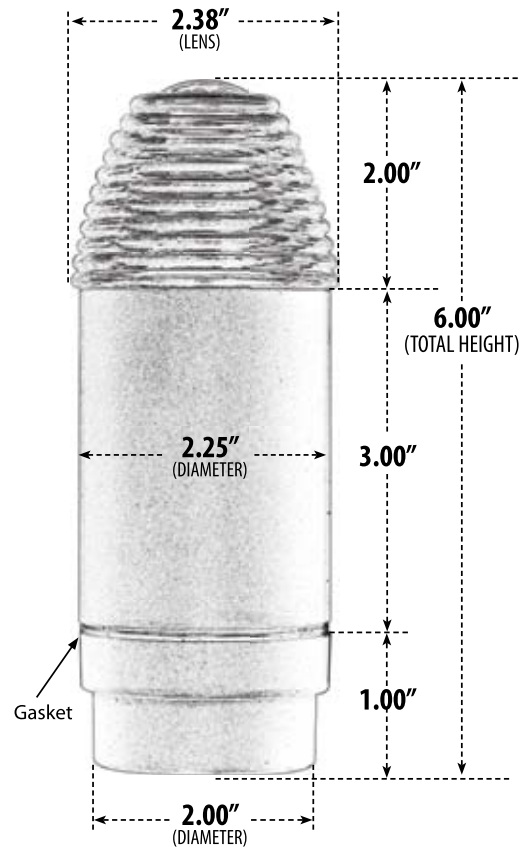

- ▶ **Material:** Powder Coated Cast Aluminum
- ▶ **Lens:** Clear, Resin Lens
- ▶ **Lamp:** JC Bi-Pin Base (20W Maximum)

MODEL NUMBER	LAMP TYPE	ILLUMINANT TYPE	WATTS (W)	VOLTS (V)	LAMP(S) INCLUDED?
LV204	JC	HALOGEN	20	12	YES

Pre-wired with UL Listed Direct Burial Wire/Cable

- ▶ **1/2" NPT**
- ▶ **Ground Spike Included for Installation**
- ▶ **Connector Available:** P-CN01 (sold separately)
- ▶ **Available Finish:** Black, Verde Green
- ▶ **ETL Approved**

Overall Dimensions:
6.00"H x 2.38"W x 2.38"D

Maximum Height: 6.00"
Width: 2.38"
Maximum Depth: 2.38"

Weight: 0.80 lbs
Approximate Wire Length: 17"
Box Dimensions:
8.50"H x 3.50"W x 3.25"D

DABMAR
LIGHTING

DABMAR LIGHTING INCORPORATED

2140 Eastman Ave . Oxnard, CA 93030 . 805.604.9090 . f: 805.604.9050 . www.dabmar.com